



DERBY3

3-in-1 Lighting Effect: Derby, LED Strobe and flood light with RGB Laser

USER MANUAL



For your safety, please read this user manual carefully before use.

Event Lighting reserves the right to revise the manual at any time. Information and specifications within this manual are subject to change without notice. Event Lighting assumes no liability or responsibility for any errors or omissions.

Please contact your local Kookaburra Account Manager for any clarification or information regarding this item.

Version 1.0

Content

Introduction----- P2

Silkscreen symbol----- P3

Safety/specification-----P4

LED Display operation-----P5

Channel -----P6-7

Remote -----P8

DMX Connection and setting - -----P9

Product size, Installation-----P10

Thank you using our LED laser series products. This fixture is the latest new LED laser product. The product housing used Aluminum plastic material, beautiful appearance, with international advanced electronic control technology and excellent industrial design. Product effect more rich, colorful, and color is gorgeous because of installed high output light source.

This product applications widely, installation simple. Can widely used for small party, home party, small club, small stage and so on.

Spare part includes:

Parts	Qty	Units
Light	1	pcs
User manual	1	pcs
Power cable	1	pcs

Cautions

Before delivery, this device has passed strict inspection, Please follow the user manual strictly for operation, if this fixture is damaged by improper operation and mistake, the fixture will be out of warranty, and manufacture or dealer won't be responsible for it. In case of any technology change in this manual, we won't advise in further .

CAUTION!



Keep this device away from rain and moisture!



Unplug mains lead before opening the housing!



Warning!

Damages caused by the disregard of this user manual are not subject to warranty. The dealer will not accept liability for any resulting defects or problems.

Silkscreen symbol

CE certificate

Only indoor using

RoHS certificate

The minimum distance from lighted objects(meter)

$T_a = \text{---} \text{ } ^\circ\text{C}$ Max ambient Temp

 $\text{---} \text{ } ^\circ\text{C}$ Max housing Temp

..... Safety caution

Be careful of burn

Danger high voltage

-----Not allow installation directly on the surface of ordinary combustibile materials

1. Safety instruction

- Once after received this product , please take and put carefully. And check cautiously that whether the product was damaged or not during the transportation, if yes, please not use this fixture and contact local dealers or manufacturers as soon as possible.
- The applicable temperature for the lighting is below 40°C. Do not use the lighting above the temperature. $t_a=40^\circ\text{C}$
- The fixture applicable widely, it must keeping clean, Please do not in overheat or dusty environment use the device. Do not touching Chemical liquid.
- Should be paid attention to the use of this product: fire, heat, electric shock, loss caused by severe or fatal injury, in electricity or to read the instructions before installation, follow the safety instruction and pay attention to the manual and warning signs on the equipment, if you have any other questions about how safe operating equipment, please contact the dealer or manufacturer as soon as possible.
- According to the procedures described in this operating instructions, please do not open by yourself. Any break, please contact professionals, and must by the professional and technical personnel for repair.
- Do not power in and open before installation. Let have a rest when continuous work for eight hours. It will longer the device using lift.
- Fixed installation, to prevent the strong vibration or impact of the device.
- The distance between the device and the projectile to keep at least 0.5 meter.
- Never look directly into the light source, as sensitive persons may suffer an epileptic shock (especially meant for epileptics)!
- When light output position of the device of dustproof glass breakage, cracks or other visible damage, user should replace the new glass to continue to use.

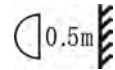

2. Installation

- When install this equipment please make sure there's no flammable (decorated things, etc) and minimum distance of 0.5M from the equipment flammable.  surfaces to the
- The installation of the effect has to be built and constructed in a way that it can hold 10 times the weight and without any harming deformation.
- The installation must always be secured with a secondary safety attachment, e.g. an appropriate safety rope. Never stand directly below the device when mounting, removing or servicing the fixture.



3. Product Specification

Input voltage: AC100-240V 50/60Hz

Fuse: BGDG ϕ 5x20mm 250VAC T2A

Power consumption: 220V 50W

LED: 2pcs 10W RGBW 4in1; Strobe: 105pcs 0.2W RGB 3in1

Laser: R: 100mw/650nm, G: 30mw/532nm, B:80mW/450nm

Scanner: motor

Control mode: sound/auto/DMX/Master-slave/remote control

Working temp: 10-40 $^\circ\text{C}$

Net weight: 5.2Kg; Gross weight: 6.5Kg

Inner packing: 51 X 29 X 29.5cm

Outer packing: 60 X 53 X 31.5cm (2pcs)

4.LED Display operation

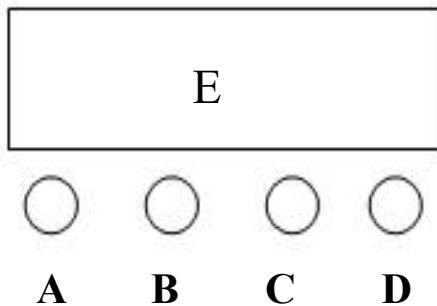

- A. (MENU)
- B. (UP)
- C. (DOWN)
- D. (ENTER)
- E. LED DISPLAY

	MENU	UP/DOWN	Value	Function
1	Addr	1-512	1	Address setting
2	ChMd	14Ch	14Ch	14 channel setting
		2Ch		2 channel setting
3	ShNd	Sh 1	Sh 7	Show 1, Led
		Sh 2		Show 2, Strobe
		Sh 3		Show 3, Laser
		Sh 4		Show 4, Led+Laser
		Sh 5		Show 5, Led+Strobe
		Sh 6		Show 6, Laser+Strobe
		Sh 7		Show 7, Led + Strobe + Laser
4	SPEE	0-100	90	Sh 1-Sh 7 speed setting
5	SLMD	MASt	MASt	Master mode
		SLAV		Slave mode
6	SoUn	ON/OFF	ON	Sound on/off
7	SoSE	0-100	90	Sound sensitivity setting
8	NodM	Prom	Prom	No DMX, Master mode
		BLAC		Standby
		HoLd		Holding last show
9	LED	ON/OFF	ON	LED Display on/off
10	Ver	V10		Version
11	Test			Lighting test

Instruction:

1.No matter what working condition, when receiving the controller signal, it will enter the DMX control mode by auto.

2.When several item in Master-slave mode, if more then 1pc item as the master, program will pick up one item as the master one randomly.

5. Channel

14CH mode

		DMX-512Value 0-255	Function
CH1	Control Mode	0-9	No function
		10-44	Show 1, Led
		45-79	Show 2, Strobe
		80-114	Show 3, Laser
		115-149	Show 4, Led + Laser
		150-184	Show 5, Led + Strobe
		185-219	Show 6, Laser + Strobe
		220-255	Show 7, Led + Strobe + Laser
CH2	RGBW color select (CH1<=9)	0-9	black-out
		10--198	Choose colors (15 groups) , each 13 data for 1 color group
		199-225	Color chase1 (single color) from slow to fast
		226-255	Color chase 2(multiple color) from slow to fast
	Sound active on/off (CH1>9)	0-247	Sound control off, Show 1-Show 7 from slow to fast
		248-255	Sound control on, Show 1-Show 7
CH3	Strobe LED	0-9	LED no strobe
		10-244	LED strobe speed from slow to fast
		245-255	LED strobe by sound
CH4	LED Motor setting	0-127	LED motor position select
		128-255	LED motor scan speed from slow to fast
CH5	Strobe LED Setting	0-9	Strobe LED off
		10-255	Strobe, LED chase effect select
CH6	Strobe chase speed	0-127	No strobe, LED chase speed from slow to fast
		127-255	With strobe, LED chase speed from slow to fast
CH7	Laser color select	0-9	Laser off
		10-127	Laser color fixed
		128-255	Color chase speed from slow to fast
CH8	Laser pattern select	0-255	Laser pattern select
CH9	Laser pattern size	0-63	Choose patterns size
		64-127	From small to large,speed up rate
		128-191	From large to small,speed up rate
		192-255	Large – small – large, speed up rate
CH10	Laser pattern rotation	0-127	Rotation angle select
		128-191	positive rotation speed

LED laser effect light user manual

		192-255	Inverted rotation speed
CH11	Laser pattern pan position	0-127	Horizontal position
		128-255	Horizontal move,speed up rate
CH12	Laser pattern tilt position	0-127	Choose vertical position
		128-255	Vertical move,speed up rate
CH13	Laser scan track choose	0-255	Track choose
CH14	Laser track scan speed choose	0-255	Laser track scan speed from slow to fast

2. 2CH mode

		DMX-512 Value	Function
		0-255	
CH1	Show mode	0-9	No function
		10-44	Show 1, Led
		45-79	Show 2, Strobe
		80-114	Show 3, Laser
		115-149	Show 4, Led + Laser
		150-184	Show 5, Led + Strobe
		185-219	Show 6, Laser + Strobe
		220-255	Show 7, Led + Strobe + Laser
CH2	Show speed/Sound active	0-247	Show 1-Show 7 speed from slow to fast
		248-255	Show 1-Show 7 Sound active

6. Remote

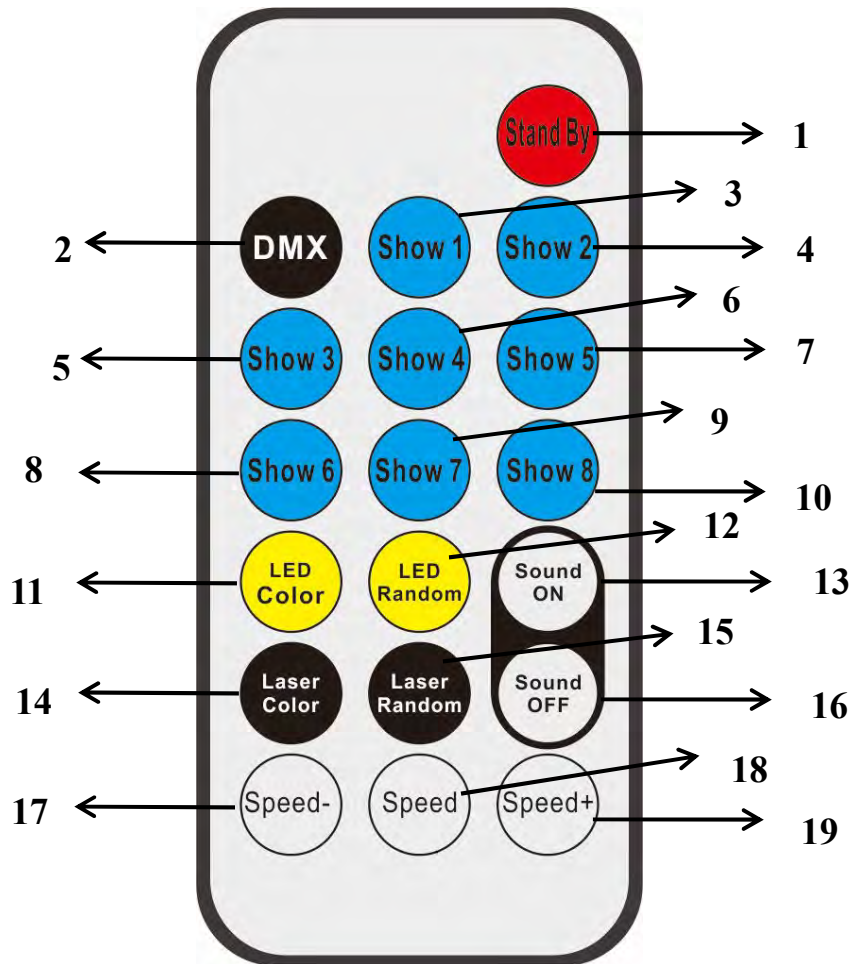

LED laser effect light user manual

Number	Button	Function
1	Stand By	Stand by
2	DMX	Hold on
3-10	Show 1-Show 8	Show1-Show7 (Show 8 hold on)
11	LED Color	LED color select
12	LED Random	LED color randomly
13	Sound ON	Sound on
14	Laser Color	Laser color select
15	Laser Random	Laser color randomly
16	Sound OFF	Sound off
17	Speed -	Show 1 - Show 7 speed down
18	Speed	Show 1 - Show 7 speed default
19	Speed+	Show 1 - Show 7 speed up

7. DMX-512 connection

3 Pin DMX output



1 Ground

2 Signal -

3 Pin DMX input



3 Signal +

14ch for example

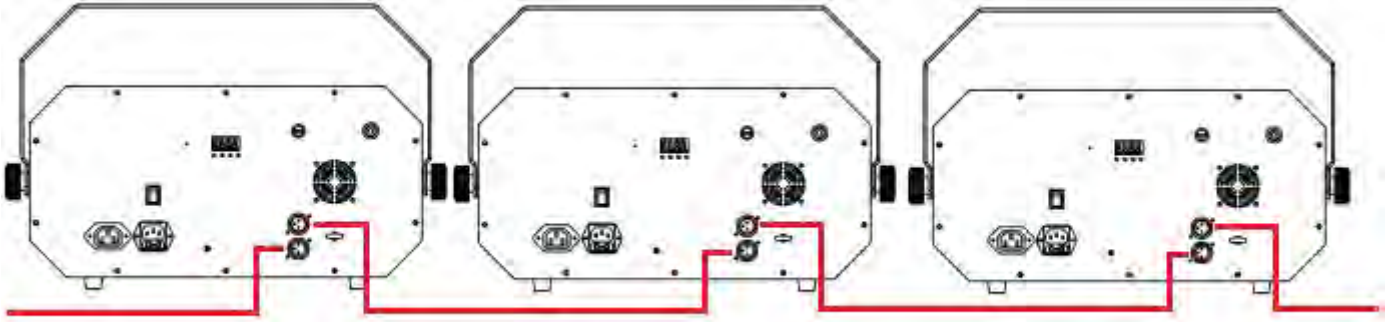

DMX in

First one add 001 Second one add 015

DMX out

Third one add 029

8. DMX address setting

Each fixture must set a specific starting address. When receiving signal, fixture will receive channel control signals of this address from the DMX controller.

For easy to use, the user can set the same address for several fixtures , also can set up a unique address for every device.

If you set the same address for all fixtures, all the fixtures will receive from the same DMX channels signal. All connecting fixtures are jointly controlled, controller can't separately control a device.

If you set a different address for each fixture, each fixture will receive unique signal and can be controlled by DMX controller separately.

This fixture has 14 channels.you should set the starting address of the first unit to 1, the second unit to 15($1 \times 14 + 1$), the third unit to 29($2 \times 14 + 1$), and so on.

9. Installation

1 Clamp

2 Handle

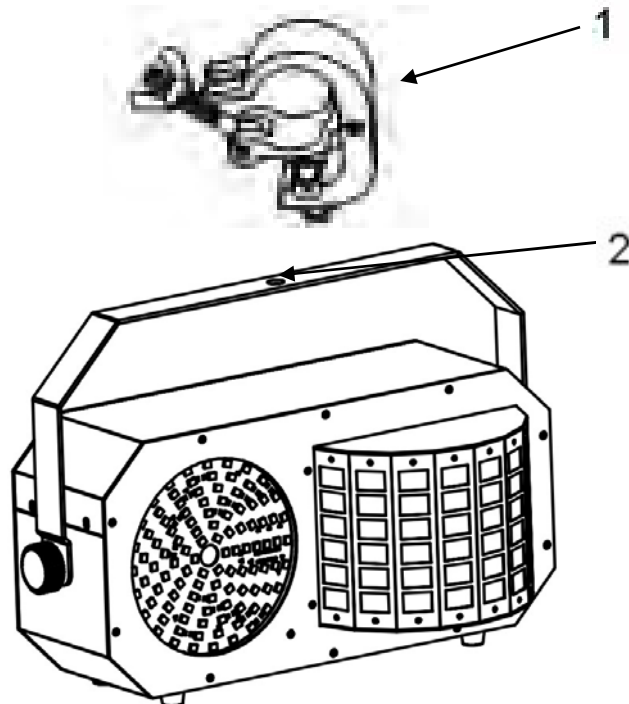

LED laser effect light user manual

When install this equipment please make sure there's no flammable surfaces (decorated things, etc) within at least 2.5M and maintain minimum distance of 0.5M from the equipment to the walls.

Please make sure that there's no other equipment or decorating materials obstructed the exhaust fan and the vent-pipe.

Products should be install immobility.

In case of safety, it's very important that to connect the earth with line.

10.Product size

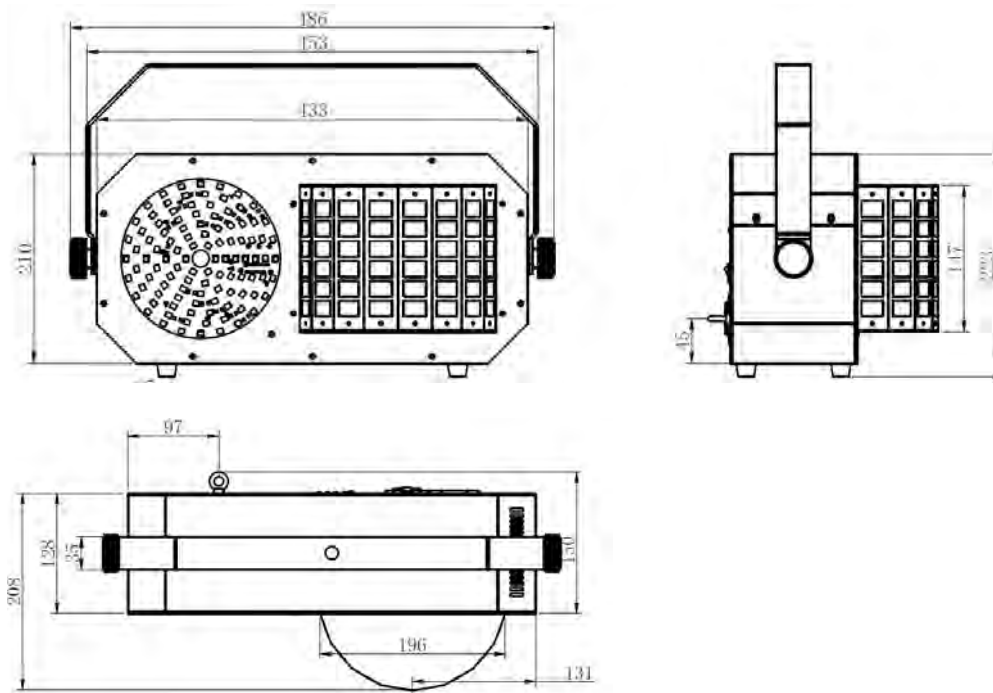

Declaration

Cleaning and maintenance

Cleaning should be performed every 15-day period, by using a sponge which is dipped with alcohol, rather than wet cloth or other chemical liquid, to clean the mirror.



CAUTION

Cut off power before cleaning and maintenance!

Attention

Do not see directly light source when open the light, and make sure power off before do any installation or maintenance.

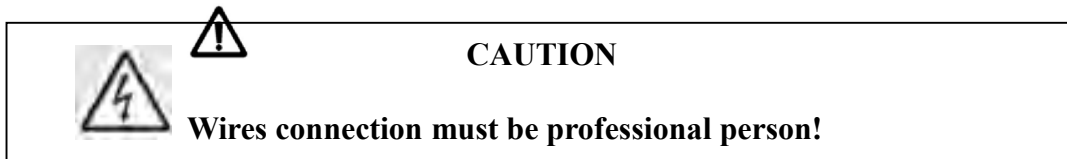
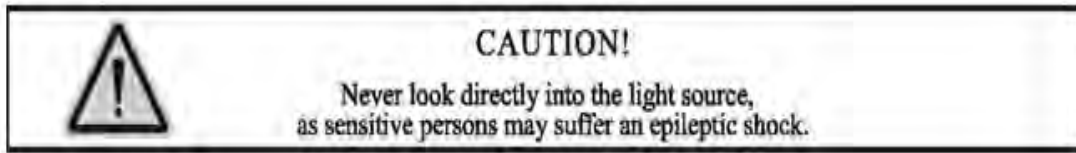

Warranty

Please contact your local Kookaburra Account Manager.